



# Bimini Top

## Assembly and Installation Instructions

Attwood marine hardware, navigational lighting, bilge pumps, and other marine accessories are specified more than any other brand by America's best-known boat manufacturers as original equipment. Look to Attwood for quality replacement parts and marine accessories.

### SAVE THESE INSTRUCTIONS

Form Number 19394R Rev. C

07-08

### FEATURES

This Attwood Bimini Top requires some assembly before installation. Please read these instructions carefully.

The Bimini Top is available in 2-bow, 3-bow or 4-bow models. Installation is basically the same for all models. Figure 1 shows the 3-bow model.

Figure 1

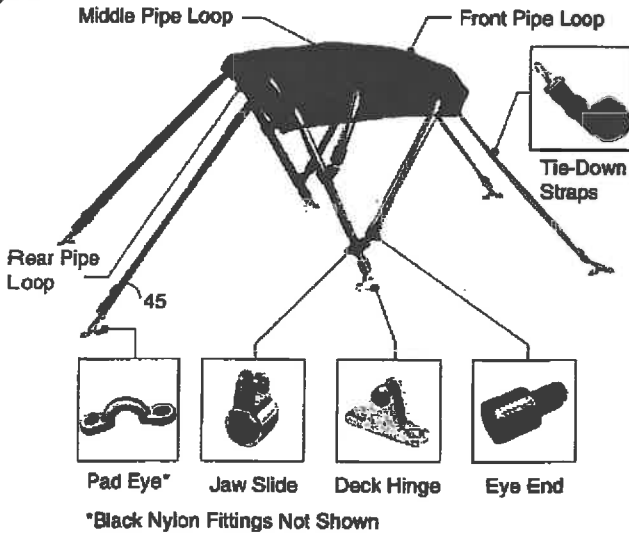

### REQUIRED FOR INSTALLATION

- Drill and 9/64" bit.
- Phillips screwdriver.

Check contents of your carton against the parts lists below.

#### 2-Bow Model

| Qty. | Description                | Qty. | Description            |
|------|----------------------------|------|------------------------|
| 2    | Long Outside Bow Sections  | 12   | #12 Sheet Metal Screws |
| 2    | Short Outside Bow Sections | 12   | #10 x 3/4" Screws      |
| 2    | Center Bow Sections        | 2    | Deck Hinges            |
| 4    | Tie-Down Straps            | 1    | Fabric Top             |
| 4    | Pad Eyes                   |      |                        |

#### 3-Bow Model

| Qty. | Description                 | Qty. | Description            |
|------|-----------------------------|------|------------------------|
| 2    | Long Outside Bow Sections   | 4    | Pad Eyes               |
| 2    | Medium Outside Bow Sections | 12   | #12 Sheet Metal Screws |
| 2    | Short Outside Bow Sections  | 12   | #10 x 3/4" Screws      |
| 3    | Center Bow Sections         | 2    | Deck Hinges            |
| 4    | Tie-Down Straps             |      |                        |

#### 4-Bow Model

| Qty. | Description                 | Qty. | Description            |
|------|-----------------------------|------|------------------------|
| 2    | Long Outside Bow Sections   | 4    | Pad Eyes               |
| 2    | Medium Outside Bow Sections | 16   | #12 Sheet Metal Screws |
| 4    | Short Outside Bow Sections  | 12   | #10 x 3/4" Screws      |
| 4    | Center Bow Sections         | 2    | Deck Hinges            |
| 4    | Tie-Down Straps             |      |                        |

### ASSEMBLE BOWS

1. Assemble all bows from two equal-length end sections and one center section.

Insert sleeves of the center sections into the end sections. Align predrilled holes at both ends and attach with 4 #12 sheet metal screws, 2 on each side. (See Figure 2.)

Figure 2

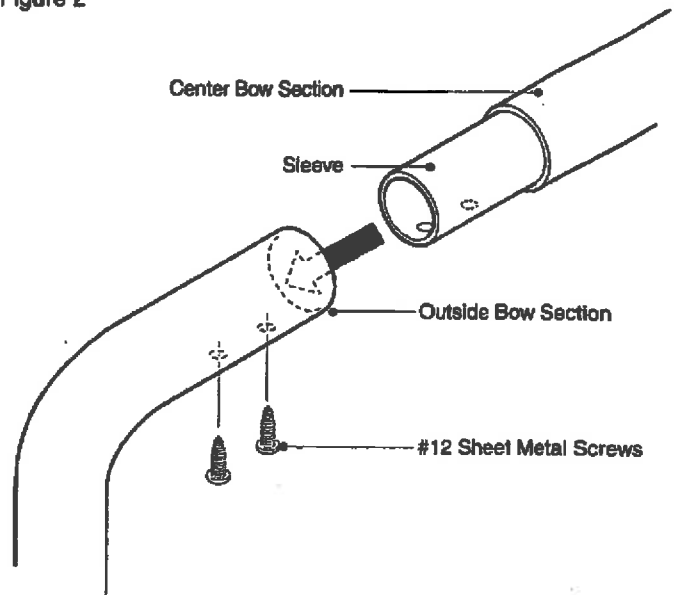

2. Spread fabric top upside down on a flat surface so the product identification label sewn into the fabric is visible. This label is sewn into the rear of the top. (See Figure 3A-3C.)

Figure 3A

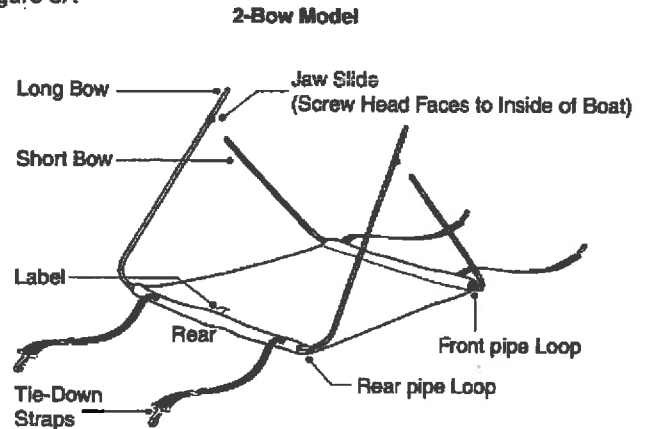

Figure 3B

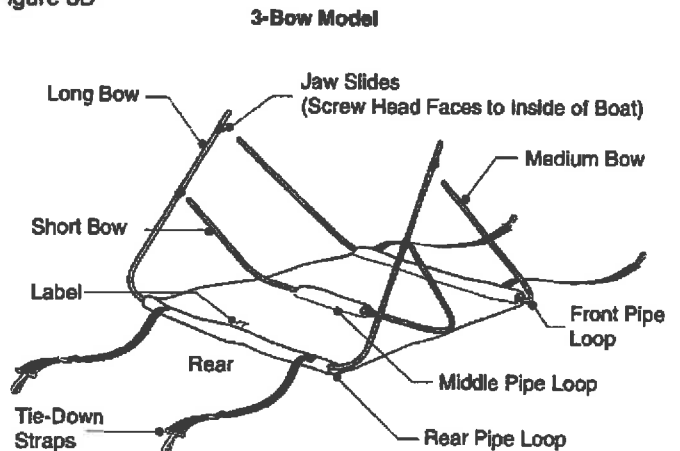
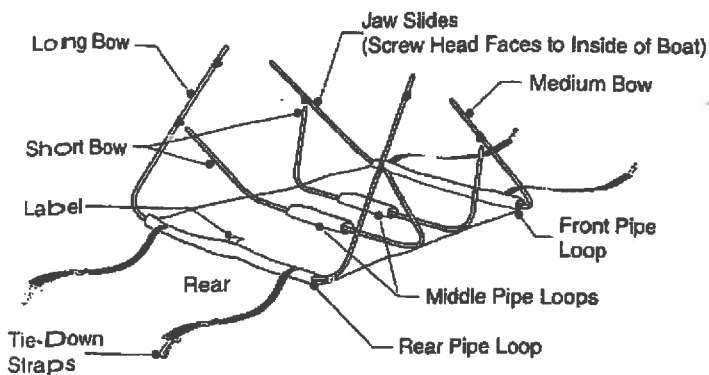

Figure 3C

4-Bow Model



3. Hold the longest bow over the rear pipe loop, where the label is sewn, with ends up. Screws on jaw slides must be toward the outside of the bimini top.

Thread the bow end into the rear pipe loop. As the end of the bow appears in each slot slide straps, buckle down, over the bow end.

4. At the front pipe loop, repeat Step 3 with the next longest bow assembly.

For 3 and 4-bow models:

5. Slide the remaining bow(s) through the end of the middle pipe loop(s).

6. To complete assembly, remove screws from all jaw slides. Insert eye ends of middle and front bows into the jaw slides, reinsert screws, and tighten. (See Figure 1.)

INSTALL BIMINI TOP

NOTE: To choose the installation site for the assembled bimini top:

- Open the top and place it over the area you want to cover.
  - When folded flat, the top should be as far aft as possible so it does not interfere with movement in the cockpit.
1. Hold the assembled top in spread-out position over the area you wish to cover (this will be easier with the help of another person). Mark the location of the bow assembly deck hinge.
  2. Place deck hinge on the gunwale at the marked position. It is critical to mount both deck hinges parallel to each other on the gunwale and at the same location on both sides of the boat. Measure reference points on gunwale to be sure both deck hinges are at the same fore-to-aft position. Mark the screw holes. (See Figure 4.)

Figure 4

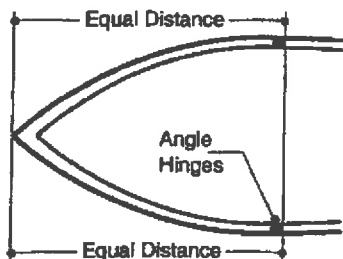

3. Drill 9/64" holes. When installing into the gel coat, use a countersink to help prevent chipping. Bed all holes with silicone caulk to help prevent water from seeping around screws. Use provided #10 x 3/4" screws to install deck hinges.
1. Position top with the longest bow assembly toward the aft. Loosen screws in deck hinges. Install eye ends in deck hinges and replace the screws.

5. Open top and hold it level with the gunwale. Extend rear tie-down straps out at a 45° angle. (See Figure 1.)

Mark where straps meet the gunwale or other mounting surface. Measure distance from the deck hinge to be certain both pad eyes are at equal distance from hinges. At marked positions, install pad eyes with two provided screws.

Repeat this procedure to install the forward pad eyes.

6. Clip hold-down straps to the pad eyes. Adjust strap buckles so top is tight and it is level.

TO FOLD TOP DOWN WHEN NOT IN USE:

1. Loosen strap buckles, release strap hooks, then fold the bows together. Wrap material around the bows. Install storage boot (available as an option from Attwood).
2. If the top doesn't fold to a convenient location, you may wish to install additional deck hinges to store the top in a better location or use Attwood Bimini Top Support Poles (Attwood part number 10639-5, sold separately) to store top in a "radar arch" position.

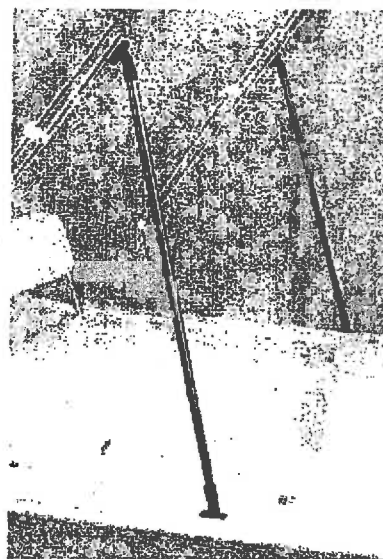

**ATTWOOD LIMITED WARRANTY** Attwood Corporation, 1016 North Monroe, Lowell, Michigan 49331 ("Attwood") warrants to the original consumer purchaser that Attwood brand products will be free from defects in materials and workmanship under normal use and service for two years from the date of original consumer purchases.

This limited warranty is not applicable if the product has been damaged by accident, improper installation, unreasonable or improper use, lack of proper maintenance, unauthorized repairs or modifications, normal wear and tear, or other causes not arising out of defects in materials or workmanship.

Attwood products are warranted for use on pleasure boats. Any other use — including but not limited to commercial, racing, or non-marine use — are not covered under this warranty. Attwood's obligation under this warranty is limited to repair of the product at Attwood's plant or replacement of the products at Attwood's option without expense to the original consumer purchaser. Any expenses involved in the removal, reinstallation or transportation of the product are not covered by this warranty.

The product must be returned to Attwood's plant at the address above, postage pre-paid, and insured with proof of original purchase including date. If Attwood is unable to replace the product and repair is not commercially practical or cannot be timely made, or if the original consumer purchaser is willing to accept a refund in lieu of repair or replacement, Attwood may refund the purchase price, less an amount for depreciation. The acceptance by Attwood of any product returned or any refund provided by Attwood shall not be deemed an admission that the product is defective or in violation of any warranty. Products that are replaced or for which a refund is issued become the property of Attwood.

**THIS WARRANTY IS ATTWOOD'S ONLY EXPRESS WARRANTY OF THIS PRODUCT. NO IMPLIED WARRANTY SHALL EXTEND BEYOND TWO (2) YEARS FROM THE DATE OF ORIGINAL CONSUMER PURCHASE. ATTWOOD SHALL NOT BE LIABLE FOR ANY DAMAGES FOR LOSS OF USE OF THIS PRODUCT, NOR FOR ANY OTHER INCIDENTAL OR CONSEQUENTIAL DAMAGES, COSTS OR EXPENSES.**

Some states do not allow limitations on how long an implied warranty lasts or the exclusion or limitation of incidental or consequential damages, so the above limitations and exclusions may not apply to you. This warranty gives you specific legal rights, and you may have other rights which vary from state to state.